



BOARD OF ZONING APPEALS APPLICATION

Click on [Meeting Schedule, Deadlines and Fees](#) for information on submitting an application to be heard at a monthly Board meeting.

APPLICANT INFORMATION	APPLICANT IS:	THIS PROPOSAL PERTAINS TO:
Name Kathryn Greer	Owner <input type="checkbox"/>	New Structure <input type="checkbox"/>
Street Address 550 W. Main St, Suite 300	Contractor <input type="checkbox"/>	Modification of Existing Structure <input type="checkbox"/>
City, State, Zip Knoxville, TN 37902	Tenant <input type="checkbox"/>	Off Street Parking <input type="checkbox"/>
Phone Number 865.357.5445	Other <input checked="" type="checkbox"/>	Signage <input type="checkbox"/>
Email kgreer@mhminc.com		Other flag pole locations <input checked="" type="checkbox"/>

THIS IS A REQUEST FOR:

<input checked="" type="checkbox"/> Zoning Variance (Building Permit Denied)	<input type="checkbox"/> Extension of Non-Conforming Use/or Structure
<input type="checkbox"/> Appeal of Administrative Official's Decision	<input type="checkbox"/> Map Interpretation

PROPERTY INFORMATION

Street Address 525 Henley Street	City, State, Zip Knoxville, TN 37902
See KGIS.org for Parcel # 094LJ001	and Zoning District DK-B / D-1 OVERLAY

VARIANCE REQUIREMENTS

City of Knoxville Zoning Ordinance Article 16, Section 16.3
 The City of Knoxville Board of Zoning Appeals shall have the power and authority to grant variances from terms of this ordinance according to the procedure and under the restrictions set out in this section.
 The purpose of the variance is to modify the strict application of the specific requirements of this ordinance in the case of exceptionally irregular, narrow, shallow or steep lots, or other exceptional physical conditions, whereby such strict application would result in practical difficulty or unnecessary hardship which would deprive an owner of the reasonable use of his land. The variance shall be used only where necessary to overcome some obstacle which is preventing an owner from using his property as the zoning ordinance intended.

DESCRIPTION OF APPEAL

Describe your project and why you need variances.
 The Knoxville Marriott flagpole locations were flagged as an issue during plans review as not meeting ZONING - Article 10.3.M. Flagpoles item 3. Flagpoles must be setback a minimum of five feet from any lot line.
 The flagpole locations were selected based on needing to be structurally independent of an existing parking deck structure below. Therefore, this is an appeal based on structural hardship.

Describe hardship conditions that apply to this variance.
 See the attached structural letter and exhibits for hardship narrative and exhibits shown.

APPLICANT AUTHORIZATION

I hereby certify that I am the authorized applicant, representing ALL property owners involved in this request and that all owners have been notified of this request in writing.

APPLICANT'S SIGNATURE Kathryn Greer Digitally signed by Kathryn Greer
DN: c=US, E=kgreer@mhminc.com, O=McCarty Holsapple McCarty, OU=McCarty Holsapple
McCarty, CN=Kathryn Greer
Date: 2021.07.15 10:02:25-0400 DATE 7/15/2021

File # 8-5-21-VA



BOARD OF ZONING APPEALS APPLICATION

*******OFFICE USE ONLY*******

Is a plat required? Yes No

Small Lot of record?

VARIANCE REQUEST(S) WITH ORDINANCE CITATION(S):

1) Reduce the minimum required setback for a flag pole from the lot line abutting Henley St from 5' to 2'3" (Article 10.3.M)

PROJECT INFORMATION

Date Filed 7/15/21

Fee Amount 500.00

Council District 6

BZA Meeting Date August 17, 2021

PLANS REVIEWER Rob Clark

DATE 7/15/21

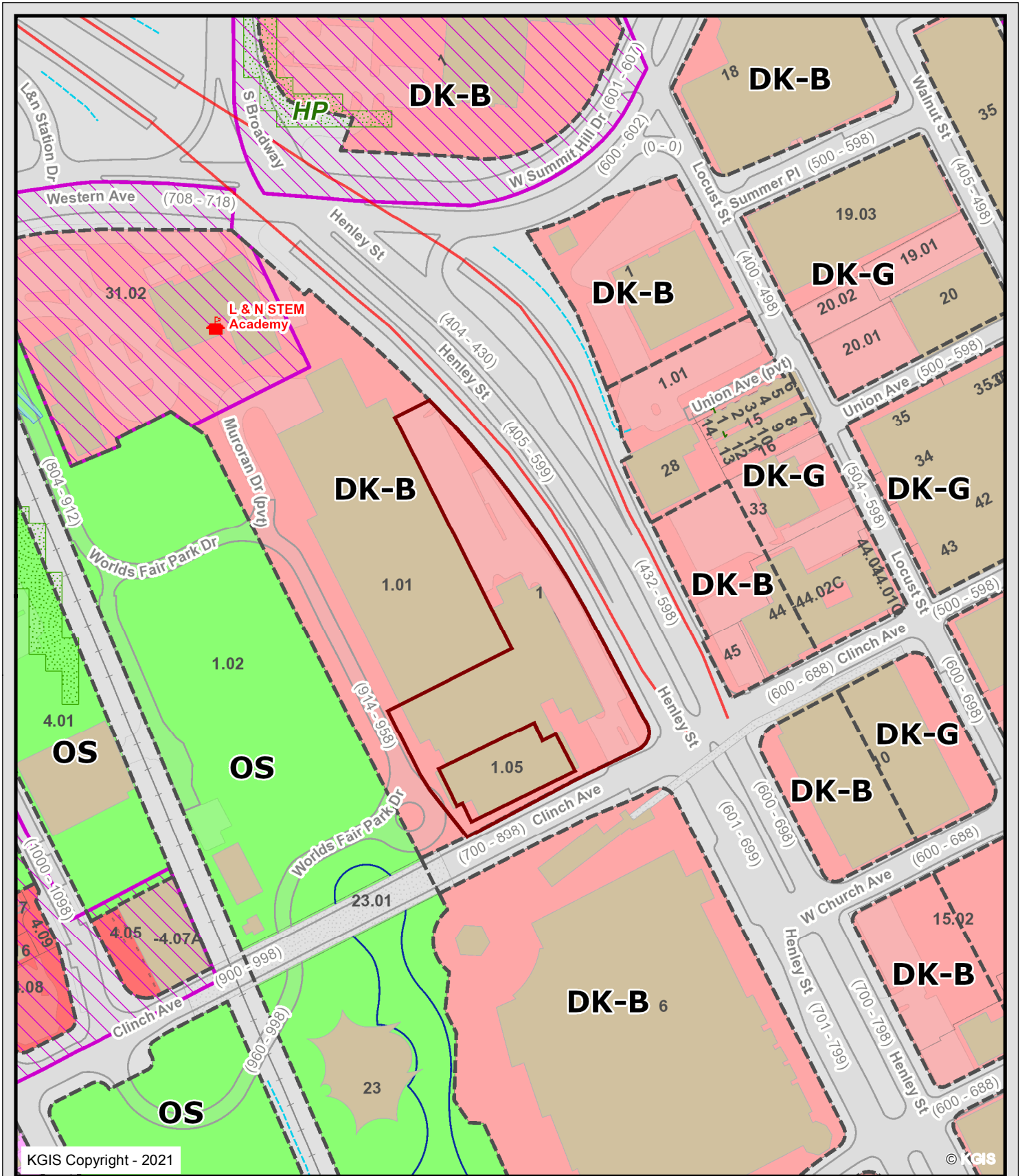

525 Henley St

8-J-21-VA

Kathryn Greer

Knoxville - Knox County - KUB Geographic Information System



Printed: 7/15/2021 at 11:18:28 AM

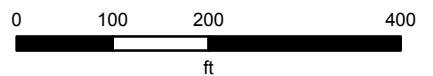

KGIS makes no representation or warranty as to the accuracy of his map and its information nor to its fitness for use. Any user of this map product accepts the same AS IS, WITH ALL FAULTS, and assumes all responsibility for the use thereof, and further covenants and agrees to hold KGIS harmless from any and all damage, loss, or liability arising from any use of this map product.

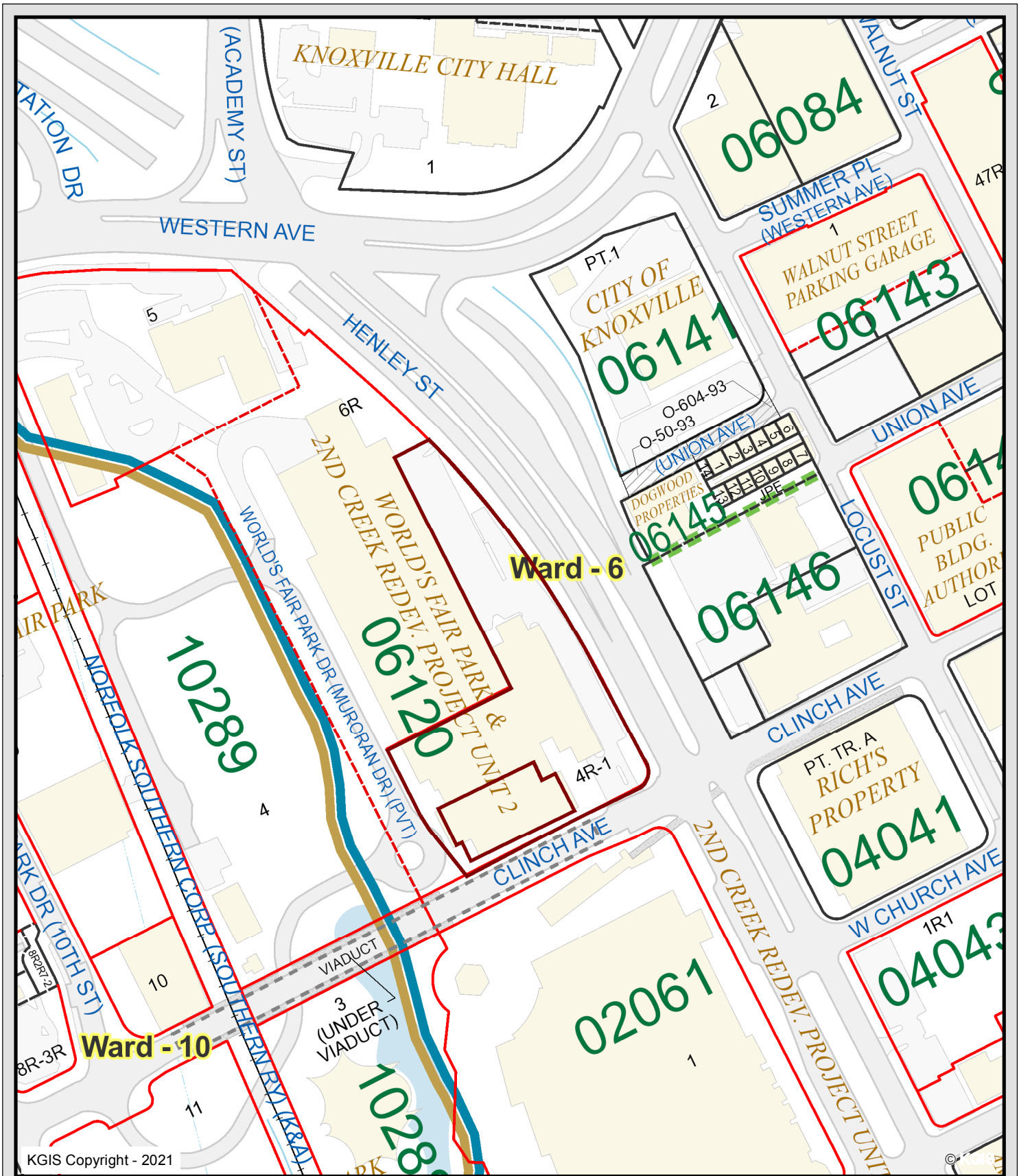

KGIS Copyright - 2021

© KGIS

525 Henley St

8-J-21-VA

Kathryn Greer

Knoxville - Knox County - KUB Geographic Information System



Printed: 7/15/2021 at 11:18:51 AM

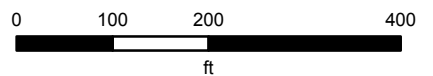

KGIS makes no representation or warranty as to the accuracy of his map and its information nor to its fitness for use. Any user of this map product accepts the same AS IS, WITH ALL FAULTS, and assumes all responsibility for the use thereof, and further covenants and agrees to hold KGIS harmless from any and all damage, loss, or liability arising from any use of this map product.



KGIS Copyright - 2021

© KGIS

525 Henley St

8-J-21-VA
Kathryn Greer

Knoxville - Knox County - KUB Geographic Information System



Printed: 7/15/2021 at 11:19:25 AM

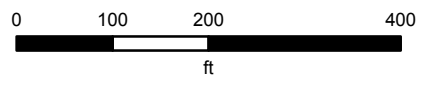

KGIS makes no representation or warranty as to the accuracy of his map and its information nor to its fitness for use. Any user of this map product accepts the same AS IS ,WITH ALL FAULTS, and assumes all responsibility for the use thereof, and futher covenants and agrees to hold KGIS harmless from any and all damage, loss, or liability arising from any use of this map product.

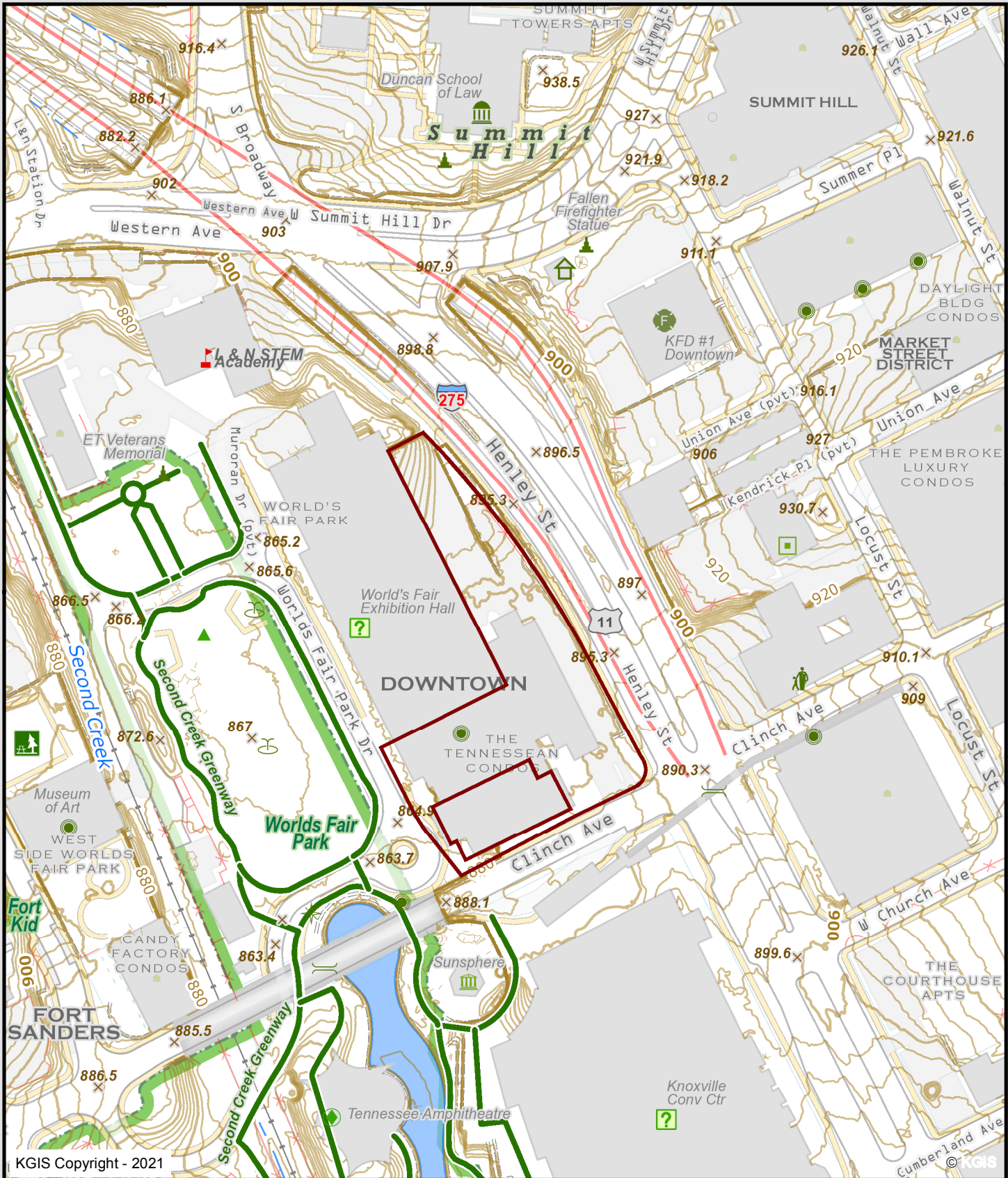

KGIS Copyright - 2021

525 Henley St

8-J-21-VA

Kathryn Greer

Knoxville - Knox County - KUB Geographic Information System



Printed: 7/15/2021 at 11:19:49 AM



KGIS makes no representation or warranty as to the accuracy of his map and its information nor to its fitness for use. Any user of this map product accepts the same AS IS, WITH ALL FAULTS, and assumes all responsibility for the use thereof, and further covenants and agrees to hold KGIS harmless from any and all damage, loss, or liability arising from any use of this map product.



July 12, 2021

Mr. Nathan Honeycutt, AIA
McCarty Holsaple McCarty
550 West Main Street, Suite 300
Knoxville, TN 37902

**Subject: Board of Zoning Appeals - Structural Hardship Letter
Knoxville Marriott Conversion
525 Henley Street
Knoxville, TN 37902**

Dear Mr. Honeycutt,

On May 21st, 2021 the structural construction documents for above-mentioned project were revised to include three new flagpoles and the structural requirements for each to be installed within the limits of the above-mentioned property. The revised structural plans and details submitted for review by the City of Knoxville.

This letter has been provided in response to a request to address concerns regarding the location of the flagpoles relative to the zoning limits of the property. We understand that the proposed location of these three flagpoles requires a variance be granted by the Board of Zoning Appeals. The zoning requirements of the property dictate the flagpoles be located atop the existing parking garage structure. In order to fasten the flagpoles to the existing parking garage structure, anchor bolts would be required to penetrate the parking deck topping, the waterproofing membrane, and the flanges of the precast concrete double-T beams. This kind of attachment is required to provide sufficient strength to prevent collapse during high winds. The full assembly penetration at each anchor bolt will increase the moisture exposure of the precast concrete structural members and the steel reinforcement within thus accelerating the degradation of the concrete and reinforcement.

Based on the information gathered during multiple onsite reviews of the parking garage structure by this office prior to the completion of the Construction Documents and our understanding of the loads imposed by tall flagpoles, it is our opinion that it is in the best interest of the existing structure to maintain the currently proposed location of the flagpoles. The proposed locations set the flagpoles off the parking deck structure, between the garage retaining wall and Henley Street, thus protecting the precast concrete garage framing from increased moisture exposure caused by the anchorage. Additionally, the parking garage retaining wall has been verified to be structurally adequate for the surcharge loads imposed by the adjacent flagpoles thus permitting a more traditional flagpole installation in soil.

If there are any questions or concerns regarding these structural recommendations, please feel free to contact us at any time.

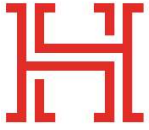

Sincerely:



Todd Whelan, P.E.
Structural Engineer

KEY	NOTE
1	EXISTING STRUCTURE TO REMAIN
2	NEW CONSTRUCTION
3	DEMOLITION
4	ADDITIONAL CONSTRUCTION
5	EXISTING DRIVEWAY
6	NEW DRIVEWAY
7	EXISTING SIDEWALK
8	NEW SIDEWALK
9	EXISTING PAVEMENT
10	NEW PAVEMENT
11	EXISTING FLOORING
12	NEW FLOORING
13	EXISTING WALLS
14	NEW WALLS
15	EXISTING CEILING
16	NEW CEILING
17	EXISTING ROOF
18	NEW ROOF
19	EXISTING MECHANICAL
20	NEW MECHANICAL
21	EXISTING ELECTRICAL
22	NEW ELECTRICAL
23	EXISTING PLUMBING
24	NEW PLUMBING
25	EXISTING HVAC
26	NEW HVAC
27	EXISTING LANDSCAPE
28	NEW LANDSCAPE
29	EXISTING UTILITIES
30	NEW UTILITIES
31	EXISTING SIGNAGE
32	NEW SIGNAGE
33	EXISTING LIGHTING
34	NEW LIGHTING
35	EXISTING FURNITURE
36	NEW FURNITURE
37	EXISTING PARTITIONING
38	NEW PARTITIONING
39	EXISTING STAIRS
40	NEW STAIRS
41	EXISTING ELEVATORS
42	NEW ELEVATORS
43	EXISTING CORE
44	NEW CORE
45	EXISTING STRUCTURE
46	NEW STRUCTURE
47	EXISTING FOUNDATION
48	NEW FOUNDATION
49	EXISTING EXTERIOR FINISHES
50	NEW EXTERIOR FINISHES

NO.	DESCRIPTION	LOCATION	MARK	FIN.	REMARKS	SOURCE
1	1	2	3	4	5	6
7	8	9	10	11	12	13
14	15	16	17	18	19	20

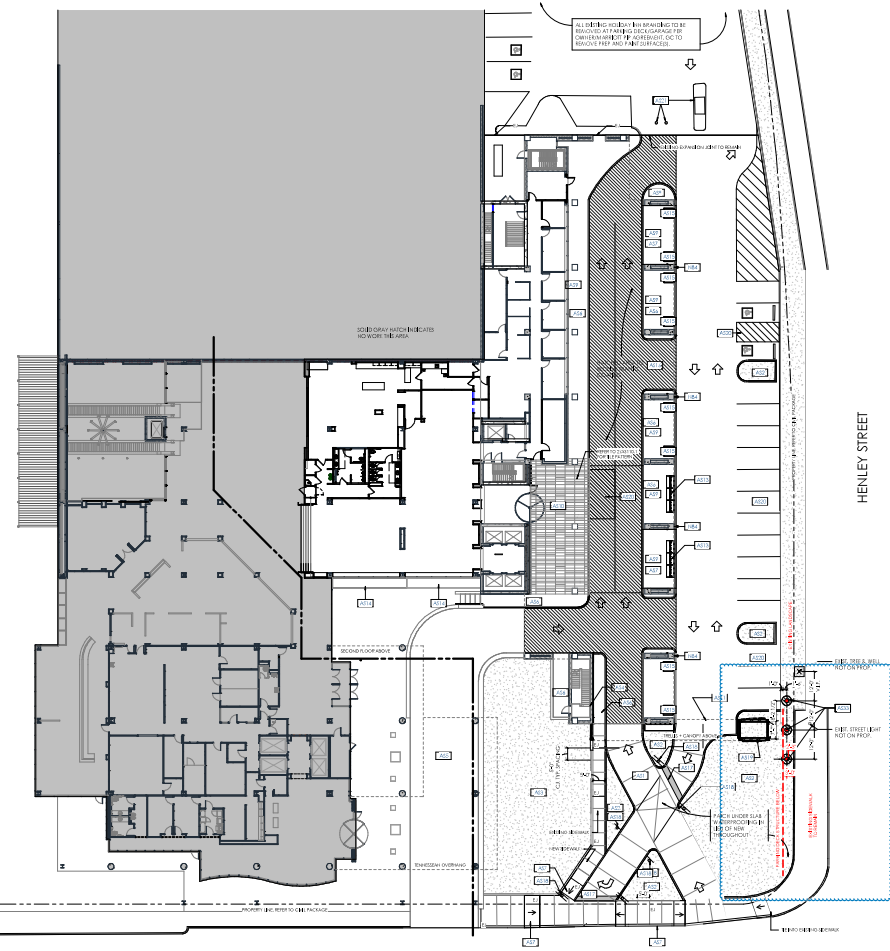
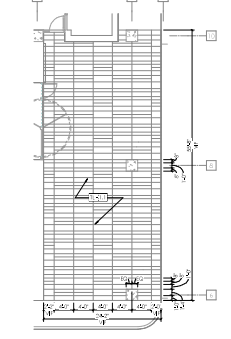

ARCHITECTURAL SITE PLAN
 AS110.1

KEY PLAN - Lower level base

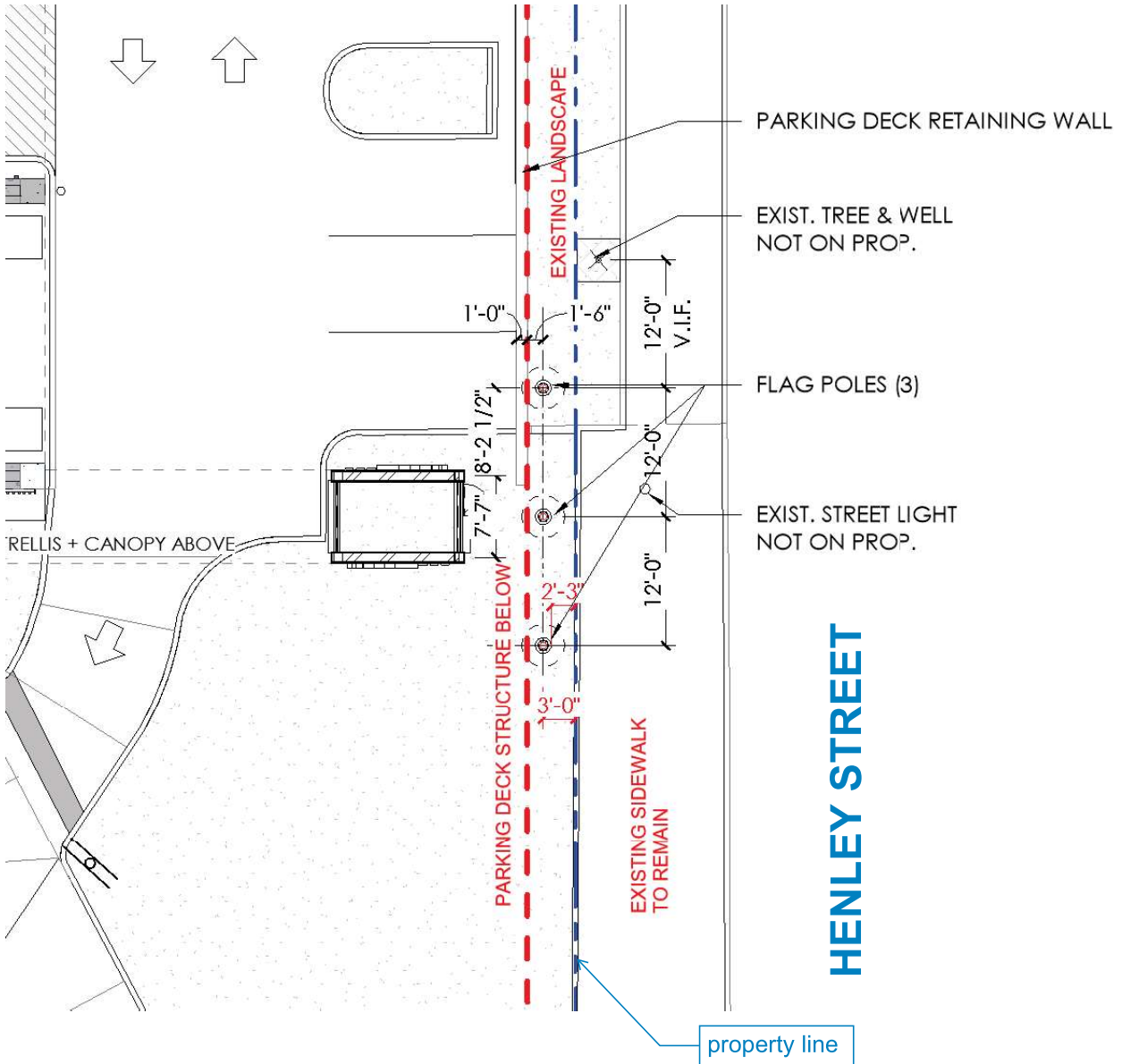

The Knoxville Marriott flagpole locations were flagged as an issue during plans review as not meeting ZONING - Article 10.3.M. Flagpoles item 3. Flagpoles must be setback a minimum of five feet from any lot line.

The flagpole locations were selected based on needing to be structurally independent of an existing parking deck structure below. Therefore, this is an appeal based on structural hardship.

MHM

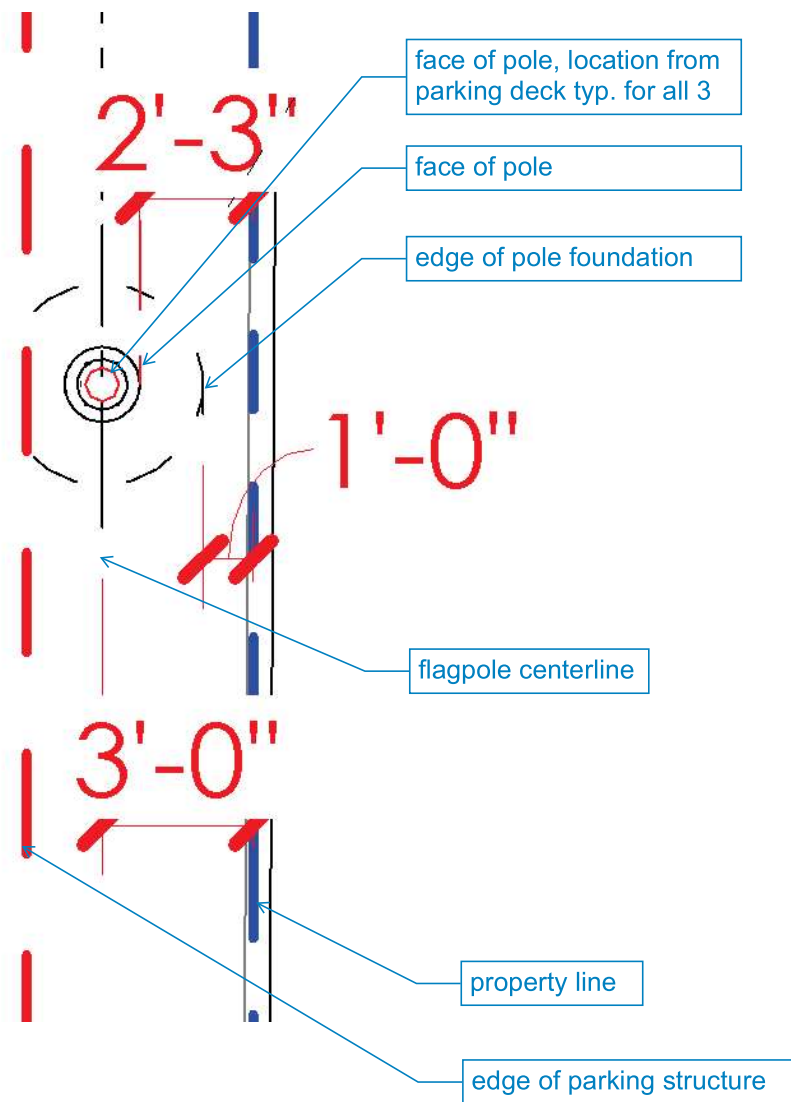

Monarch Series - ICC

Internal Cam Cleat - Rope Halyard

The **Monarch Series** from Concord American Flagpole offers commercial-grade flagpoles with the security of an Internal Rope Halyard and Cam Cleat system. Ranging in heights from **20' to 40'**, the concealed halyard and lockable flush mount hinged door delivers project owners the peace of mind provided with 24-7 security.

STANDARD FLAGPOLE ACCESSORIES - 5" TO 8" BUTT DIAMETERS

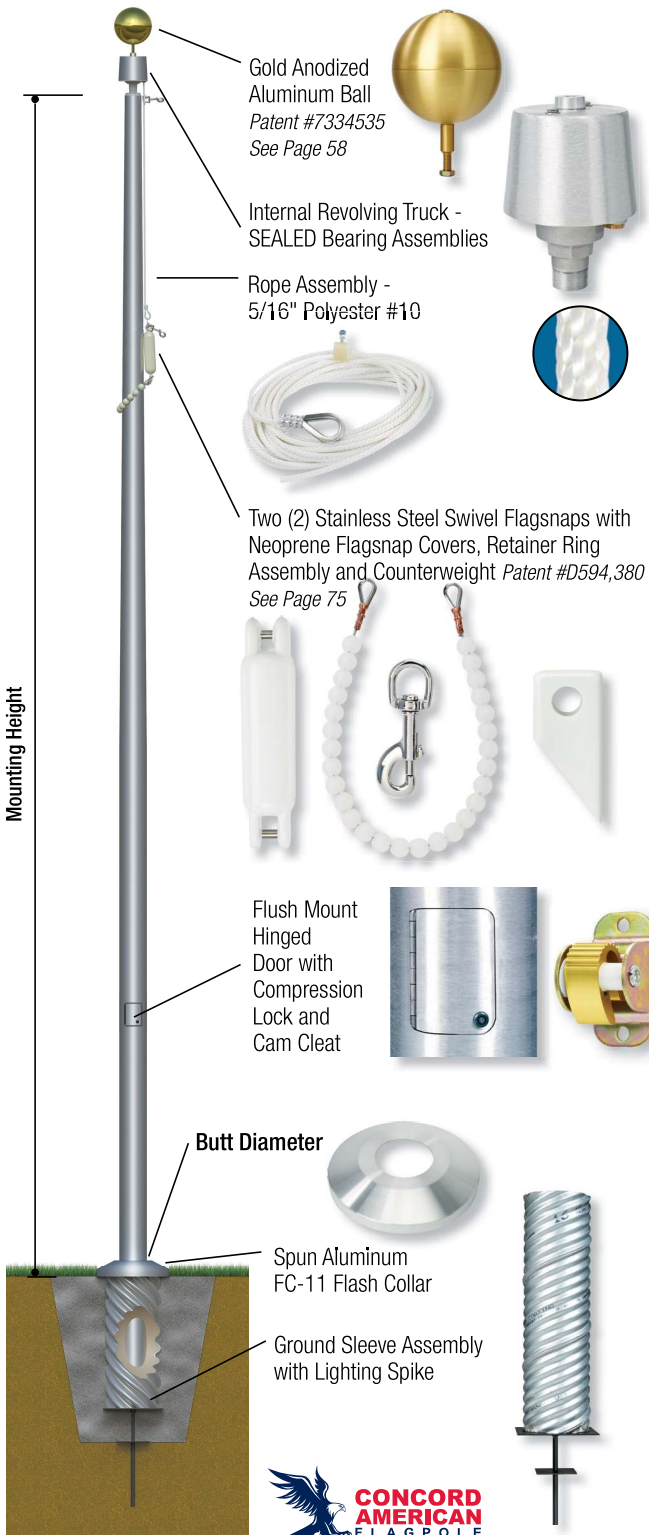

Standard Specifications

- Patented, Heavy-Duty Gold Anodized Aluminum Ball
- Cast Aluminum Revolving Truck with SEALED Stainless Steel Bearing Assemblies, Aluminum Spindle, Cast Brass Exit Bushing and Removable Hood
- Complete Internal Halyard Assembly
 - Rope Halyard – 5/16" #10 Polyester
 - Two (2) Stainless Steel Swivel Flagsnaps
 - Two (2) Neoprene Flagsnap Covers
- Cam Cleat
- Flush Mount Access Door with Lock and Keys
- Spun Aluminum FC-11 Flash Collar
- Galvanized 16-Gauge Corrugated Steel Ground Sleeve with Steel Grounding Spike

Flush Mount Hinged Door Design

Monarch Flagpoles unite the simplicity of efficient engineering with the aesthetics of a precision cut, rectangular flush mount door design, providing an internal halyard Cam Cleat system that is ideal for low to moderate wind speed areas.

For additional Cam Cleat option flagpoles, see Sentry ISC Raised Reinforced Door Frame (Page 26) and Sentry II IRC Reinforced Welded Door Frame (Page 28).



Monarch Series - ICC Internal Cam Cleat - Rope Halyard

MTG HGT.	BUTT DIA.	WALL THICKNESS	POLE SECTIONS	SET DEPTH	TOP DIAM.	STD FLAG SIZE	MAX WIND SPEED WITH NYLON FLAG	MAX WIND SPEED NO FLAG	CATALOG NUMBER ***SPECIFY FINISH	Satin	CLEAR ANODIZED	DARK BRONZE OR BLACK ANODIZED	BRONZE TONE, BLACK, WHITE, OR CLEAR POWDERCOAT
20'	5"	.125"	1	2'0"	3"	4' x 6'	117	204	ICC20B51-***	\$1,812	\$2,037	\$2,101	\$1,958
	5"	.188"	1	2'0"	3"	4' x 6'	151	272	ICC20D51-***	\$2,062	\$2,290	\$2,354	\$2,212
25'	5"	.125"	1	2'6"	3"	5' x 8'	84	110	ICC25B51-***	\$1,936	\$2,228	\$2,290	\$2,116
	5"	.156"	1	2'6"	3"	5' x 8'	93	129	ICC25C51-***	\$2,170	\$2,418	\$2,527	\$2,338
	6"	.156"	1	2'6"	3.5"	5' x 8'	126	216	ICC25C61-***	\$2,529	\$2,830	\$2,972	\$2,702
	6"	.188"	1	2'6"	3.5"	5' x 8'	144	240	ICC25D61-***	\$2,669	\$3,003	\$3,146	\$2,860
30'	5"	.156"	1	3'0"	3"	6' x 10'	72	90	ICC30C51-***	\$2,342	\$2,686	\$2,797	\$2,560
	5"	.156"	2	3'0"	3"	6' x 10'	72	90	ICC30C52-***	\$2,578	\$2,952	\$3,076	\$3,032
	6"	.156"	1	3'0"	3.5"	6' x 10'	91	138	ICC30C61-***	\$2,670	\$3,050	\$3,194	\$2,894
	6"	.156"	2	3'0"	3.5"	6' x 10'	91	138	ICC30C62-***	\$2,825	\$3,210	\$3,336	\$3,050
	6"	.188"	1	3'0"	3.5"	6' x 10'	102	170	ICC30D61-***	\$2,937	\$3,355	\$3,513	\$3,185
	6"	.188"	2	3'0"	3.5"	6' x 10'	102	170	ICC30D62-***	\$3,113	\$3,530	\$3,671	\$3,328
35'	6"	.156"	1	3'6"	3.5"	6' x 10'	74	93	ICC35C61-***	\$2,841	\$3,466	\$3,602	\$3,083
	6"	.156"	2	3'6"	3.5"	6' x 10'	74	93	ICC35C62-***	\$3,124	\$3,811	\$3,961	\$3,392
	7"	.156"	1	3'6"	3.5"	6' x 10'	95	142	ICC35C71-***	\$3,136	\$3,590	\$3,781	\$3,385
	7"	.156"	2	3'6"	3.5"	6' x 10'	95	142	ICC35C72-***	\$3,450	\$3,950	\$4,160	\$3,724
	7"	.188"	1	3'6"	3.5"	6' x 10'	107	167	ICC35D71-***	\$3,542	\$4,003	\$4,192	\$3,798
	7"	.188"	2	3'6"	3.5"	6' x 10'	107	167	ICC35D72-***	\$3,896	\$4,405	\$4,612	\$4,179
40'	7"	.156"	1	4'0"	3.5"	8' x 12'	75	99	ICC40C71-***	\$3,678	\$4,303	\$4,466	\$4,116
	7"	.156"	2	4'0"	3.5"	8' x 12'	75	99	ICC40C72-***	\$4,046	\$4,734	\$4,914	\$4,529
	8"	.156"	1	4'0"	4"	8' x 12'	94	140	ICC40C81-***	\$3,920	\$4,496	\$4,670	\$4,151
	8"	.156"	2	4'0"	3.5"	8' x 12'	94	140	ICC40C82-***	\$4,116	\$4,614	\$4,864	\$4,366
	8"	.188"	1	4'0"	4"	8' x 12'	107	161	ICC40D81-***	\$4,312	\$4,947	\$5,138	\$4,566
	8"	.188"	2	4'0"	3.5"	8' x 12'	107	161	ICC40D82-***	\$4,529	\$5,075	\$5,349	\$4,801

***** - Finish Options**

- SAT = Satin
- ACL = Anodized - Clear
- ADB = Anodized - Dark Bronze
- ABL = Anodized - Black
- BZT = Powder Coat - Bronze Tone
- BLK = Powder Coat - Black
- WHT = Powder Coat - White
- CLR = Powder Coat - Clear

Quantity Discounts

5+ = 5% 8+ = 10% 15+ = 12%
 *Flagpoles From All Flagpole Series May Be Combined To Achieve Quantity Discounts.

MONARCH SERIES - ICC OPTIONS

Cast Aluminum, SEALED Bearings, Gold Powder Coated Ball Truck.
 Replaces Standard Truck and Ball Combination - See Page 68.

8" Diameter Ball/Truck Add **\$151**
 10" Diameter Ball/Truck Add **\$348**



Cast Aluminum FC-11 In Lieu of Spun Collar - See Page 81.
 5"-7" Butt Diameters Add **\$62**
 8" Butt Diameters Add **\$186**



Flagpole Lighting Options are available for all Monarch Series ICC Flagpoles - See Pages 84-91.

Shoe Base Designs for Surface Mount Installations are available with all Monarch Series - ICC Flagpoles. See Page 14.

5" Butt Diameters Add **\$227**
 6"-8" Butt Diameters Add **\$281**

a

August 9, 2021

Mr. Scott Elder
Board of Zoning Appeals
Room 475, City-County Building
P. O. Box 1631
Knoxville, Tennessee 37901

Dear Mr. Elder:

Re: Variance Requests 8-A-21-VA, 8-C-21-VA, 8-F-21-VA, 8-G-21-VA, 8-I-21-VA, and 8-J-21-VA

We have reviewed our records and, as far as we have been able to determine, KUB has no existing utility facilities located within the variance areas and we have no objection to the requested variances. However, KUB does not release and hereby retains all easements and rights for existing facilities, whether or not identified in our research.

If you have any questions regarding this matter, please call me at (865) 558-2483.

Sincerely,



Christian Wiberley, P.E.
Engineering

CGW

RE: BZA August applications

Steve Borden <Steve.Borden@tn.gov>

Mon 8/9/2021 4:31 PM

To: Cheri Burke <cmburke@knoxvilletn.gov>

Please find the following responses from TDOT District 18 Operations for the July BZA applications:

8-A-21-VA: 1301 Wilshire Rd: Operations has no comment
8-C-21-VA: 3001 Knoxville Center Dr: Operations has comment
8-F-21-VA: 6202 Westland Dr: Operations has comment
8-G-21-VA: 700 Eleanor St: Operations has comment
8-I-21-VA: 10865 Parkside Dr: Operations has comment
8-J-21-VA: 525 Henley St: Operations has comment

If you have further questions, please let me know.



Steven M. Borden, P.E. | Director/Assistant Chief Engineer

TDOT – Region 1

7345 Region Lane

Knoxville, TN 37914

(865) 594-2400

Steve.Borden@tn.gov

tn.gov/tdot

From: Cheri Burke <cmburke@knoxvilletn.gov>

Sent: Tuesday, August 3, 2021 11:53 AM

To: Steve Borden <Steve.Borden@tn.gov>

Subject: [EXTERNAL] BZA August applications

***** This is an EXTERNAL email. Please exercise caution. DO NOT open attachments or click links from unknown senders or unexpected email - STS-Security. *****

Good morning Steve,

Please have your staff review the applications located [at this link](#) and provide your response by 8/9/21, if at all possible.

8-A-21-VA: 1301 Wilshire Rd
8-C-21-VA: 3001 Knoxville Center Dr
8-F-21-VA: 6202 Westland Dr
8-G-21-VA: 700 Eleanor St

8-I-21-VA: 10865 Parkside Dr

8-J-21-VA: 525 Henley St

Thank you!

Cheri Burke

Administrative Specialist

Neighborhood Codes Enforcement

City of Knoxville

865-215-2867

865-215-2119